

216.5

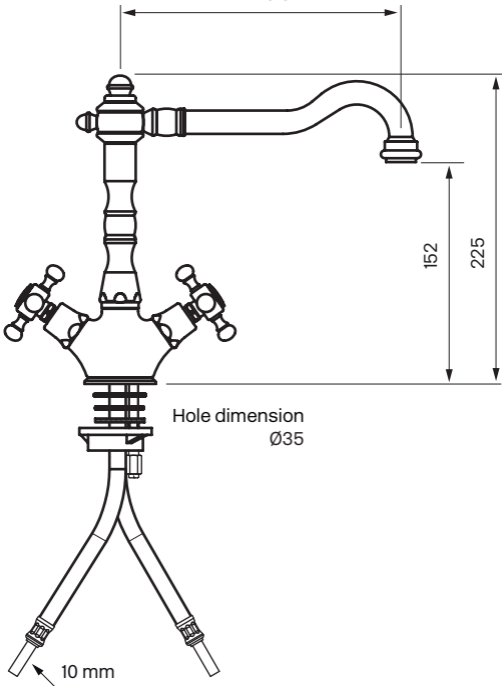

152

225

Hole dimension
Ø35

10 mm